



Firma _____ Datum: _____
 Ansprechpartner _____
 eMail _____
 Kommission _____

Preise und technische Daten können sich ohne vorherige Ankündigung ändern.

STANDARD KONFIGURATION

- fester Rahmen
- max. Sitzwinkelverstellung bis 45°
- dynamisch, aktive Rückenlehne mit Gasdruckfeder (90°-125°)
- dynamischer Sitz
- im Winkel verstellbar & abnehmbare Beinstützen (90°-160°)
- separate Fußplatten, hochklappbar, in Höhe, Winkel und Tiefe einstellbar
- Antikippräder rechts und links
- Schiebegriffe gebogene Rohre
- Bedienung für Sitzkantelung an Schiebegriffen montiert
- Peezy Light Sitzkissen
- Contour Rückenlehne
- Kopfstütze (Straight Contoured + C-Bracket)

ANATOMISCHE MAßE

Länge	_____	cm
Gewicht	_____	kg
1 - Oberschenkellänge	_____	cm
2 - Brusttiefe	_____	cm
3 - Achselhöhlenhöhe	_____	cm
4 - Schulterhöhe	_____	cm
5 - Kopfhöhe	_____	cm
6 - Ellbogenhöhe	_____	cm
7 - Unterschenkellänge	_____	cm
8 - Ellbogen bis Hand	_____	cm
9 - Schulterbreite	_____	cm
10 - Brustbreite	_____	cm
11 - Hüftbreite	_____	cm

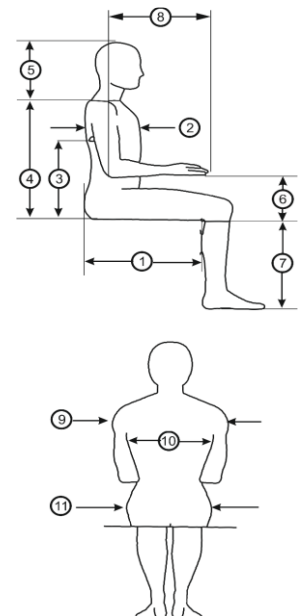

TECHNISCHE INFORMATIONEN

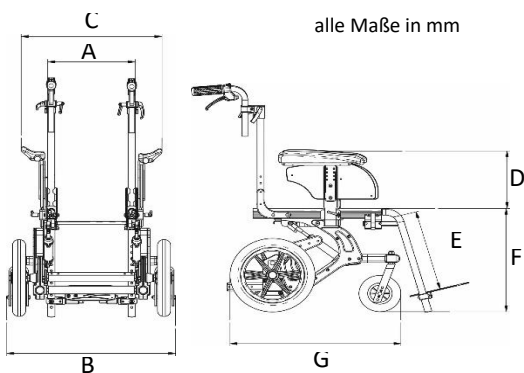

	A - Sitzbreite	300	340	380	420	460
B - Sitzbreite inkl. Reifen	485	525	565	605	645	
C - Armlehnenbreite (mit Standard Armlehnen)	410	450	490	530	570	
D - Armlehnenhöhe	180:270 or 270:360					
E - Beinlänge	150:380					
F - Sitzhöhe	470					
G - Länge	Ø300 mm: min. 610, max. 720 Ø400 mm: min. 665, max. 770					

ROLLSTUHLGRÖßE

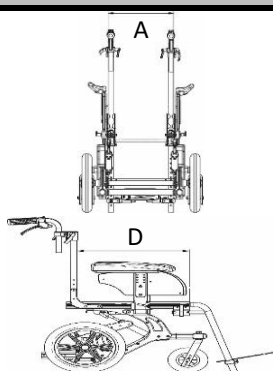

A - Sitzbreite 30 cm	D - Sitztiefe 34 : 42 cm	<input type="checkbox"/>	€ 0,00	114763
A - Sitzbreite 34 cm	D - Sitztiefe 34 : 42 cm	<input type="checkbox"/>	€ 0,00	114764
	D - Sitztiefe 42 : 50 cm	<input type="checkbox"/>	€ 0,00	114765
A - Sitzbreite 38 cm	D - Sitztiefe 38 : 46 cm	<input type="checkbox"/>	€ 0,00	114766
	D - Sitztiefe 46 : 54 cm	<input type="checkbox"/>	€ 0,00	114767
A - Sitzbreite 42 cm	D - Sitztiefe 42 : 50 cm	<input type="checkbox"/>	€ 0,00	114768
	D - Sitztiefe 50 : 54 cm	<input type="checkbox"/>	€ 0,00	114769
A - Sitzbreite 44 cm	D - Sitztiefe 46 : 54 cm	<input type="checkbox"/>	Auf Anfrage	116944
A - Sitzbreite 46 cm	D - Sitztiefe 46 : 54 cm	<input type="checkbox"/>	Auf Anfrage	116906

PEEZY & PEEZY LIGHT SITZKISSEN

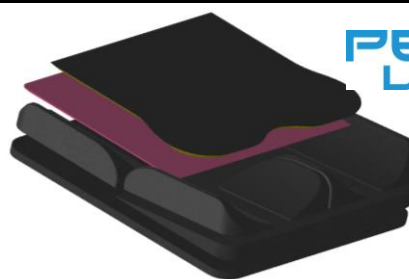

PEEZY

PEEZY
LIGHT

		PEEZY LIGHT	PEEZY
Sitzbreite 26 cm	max. Sitztiefe 30 cm	<input type="checkbox"/> € 0,00	<input type="checkbox"/> € 735,00
Sitzbreite 30 cm	max. Sitztiefe 34 cm	<input type="checkbox"/> € 0,00	<input type="checkbox"/> € 735,00
Sitzbreite 30 cm	max. Sitztiefe 40 cm	<input type="checkbox"/> € 0,00	<input type="checkbox"/> € 735,00
Sitzbreite 34 cm	max. Sitztiefe 44 cm	<input type="checkbox"/> € 0,00	<input type="checkbox"/> € 735,00
Sitzbreite 36 cm	max. Sitztiefe 44 cm	<input type="checkbox"/> € 0,00	<input type="checkbox"/> € 735,00
Sitzbreite 38 cm	max. Sitztiefe 48 cm	<input type="checkbox"/> € 0,00	<input type="checkbox"/> € 735,00
Sitzbreite 42 cm	max. Sitztiefe 44 cm	<input type="checkbox"/> € 0,00	<input type="checkbox"/> € 735,00
Sitzbreite 42 cm	max. Sitztiefe 52 cm	<input type="checkbox"/> € 0,00	<input type="checkbox"/> € 735,00
Sitzbreite 44 cm	max. Sitztiefe 50 cm	<input type="checkbox"/> € 0,00	<input type="checkbox"/> € 735,00
Sitzbreite 48 cm	max. Sitztiefe 52 cm	<input type="checkbox"/> € 0,00	<input type="checkbox"/> € 735,00
Inkontinenzbezug		<input type="checkbox"/>	€ 162,00

RÜCKENLEHNE BEK ROUND

Rückenlehnen Größe

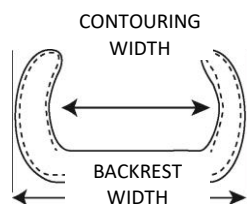

Minimale breite = 15 cm weniger als Rückenbreite

Maximale breite = 8 cm weniger als Rückenbreite

Breite 30 cm*	Höhe 35 cm	<input type="checkbox"/>	€ 0,00	115263
	Höhe 40 cm	<input type="checkbox"/>	€ 0,00	115264
Breite 34 cm*	Höhe 40 cm	<input type="checkbox"/>	€ 0,00	115265
	Höhe 45 cm	<input type="checkbox"/>	€ 0,00	115266
Breite 38 cm*	Höhe 45 cm	<input type="checkbox"/>	€ 0,00	115267
	Höhe 50 cm	<input type="checkbox"/>	€ 0,00	115268
Breite 42 cm*	Höhe 45 cm	<input type="checkbox"/>	€ 0,00	115269
	Höhe 50 cm	<input type="checkbox"/>	€ 0,00	115270
	Höhe 55 cm	<input type="checkbox"/>	€ 0,00	115271
Breite 46 cm*	Höhe 45 cm	<input type="checkbox"/>	€ 0,00	115272
	Höhe 50 cm	<input type="checkbox"/>	€ 0,00	115273
Breite 50 cm*	Höhe 55 cm	<input type="checkbox"/>	€ 0,00	115274
	Höhe 55 cm	<input type="checkbox"/>	€ 0,00	115275

RÜCKENLEHNE BEK SHIFT MIT WEGSCHWENKBAREN PELOTTEN

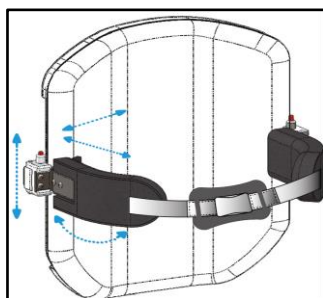

WEGSCHWENKBAR HUG



Breite 26 cm* <small>*für Rollstuhlbreite 24 bis 28 cm</small>	Höhe 30 cm	<input type="checkbox"/>	€ 730,00	115277
Breite 30 cm* <small>*für Rollstuhlbreite 26 bis 30 cm</small>	Höhe 35 cm	<input type="checkbox"/>	€ 730,00	115278
	Höhe 40 cm	<input type="checkbox"/>	€ 730,00	115279
Breite 34 cm* <small>*für Rollstuhlbreite 30 bis 34 cm</small>	Höhe 40 cm	<input type="checkbox"/>	€ 730,00	115280
	Höhe 45 cm	<input type="checkbox"/>	€ 730,00	115281
Breite 38 cm* <small>*für Rollstuhlbreite 34 bis 38 cm</small>	Höhe 45 cm	<input type="checkbox"/>	€ 730,00	115282
	Höhe 50 cm	<input type="checkbox"/>	€ 730,00	115283
Breite 42 cm* <small>*für Rollstuhlbreite 38 bis 42 cm</small>	Höhe 45 cm	<input type="checkbox"/>	€ 730,00	115284
	Höhe 50 cm	<input type="checkbox"/>	€ 730,00	115285
	Höhe 55 cm	<input type="checkbox"/>	€ 730,00	115286
Breite 46 cm* <small>*für Rollstuhlbreite 42 bis 46 cm</small>	Höhe 45 cm	<input type="checkbox"/>	€ 730,00	115287
	Höhe 50 cm	<input type="checkbox"/>	€ 730,00	115288
	Höhe 55 cm	<input type="checkbox"/>	€ 730,00	115289
Breite 50 cm* <small>*für Rollstuhlbreite 46 bis 50 cm</small>	Höhe 55 cm	<input type="checkbox"/>	€ 730,00	115290



Weitere Pelotten finden Sie in unserem Zubehörformular.





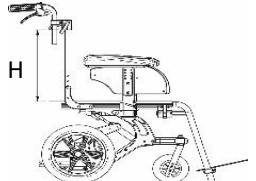





RÄDER

Hinterräder				
Radgröße	12,5"	<input type="checkbox"/>	€ 0,00	114770
	16"	<input type="checkbox"/>	STANDARD	114771
	24"	<input type="checkbox"/>	Auf Anfrage	Sonderbau
Reifentyp	Luftbereifung	<input type="checkbox"/>	STANDARD	114772
	PU-Bereifung	<input type="checkbox"/>	€ 0,00	114773
Trommelbremsen		<input type="checkbox"/>	€ 305,00	115261
Schwenkräder				
Größe, Typ und Farbe	Ø150 mm PU schwarz	<input type="checkbox"/>	STANDARD	114774
	Ø175 mm PU schwarz	<input type="checkbox"/>	€ 0,00	114775

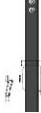

RÜCKENLEHNEN

Rückenlehnenverstellung					
 	Dynamisch, aktive Rückenlehne mit Gasdruckfeder (90° - 125°)	50 N	<input type="checkbox"/>	€ 0,00	114776
		100 N	<input type="checkbox"/>	STANDARD	114777
		150 N	<input type="checkbox"/>	€ 0,00	114778
		200 N	<input type="checkbox"/>	€ 0,00	114779
Rückenlehnenrahmenhöhe					
	Rückenlehnenrahmenhöhe: 45 cm	<input type="checkbox"/>	€ 0,00	114780	
	Rückenlehnenrahmenhöhe: 50 cm	<input type="checkbox"/>	STANDARD	114781	
	Rückenlehnenrahmenhöhe: 55 cm	<input type="checkbox"/>	€ 0,00	114782	

Schiebegriffe			
	Schiebegriffe, separat in Höhe einstellbar	<input type="checkbox"/>	€ 0,00
	Schiebegriffe, gebogene Rohre, separat in Höhe einstellbar	<input type="checkbox"/>	STANDARD
	durchgehender Schiebebügel	<input type="checkbox"/>	€ 0,00

KOPFSTÜTZEN HALTER					
	C-Bracket	<input type="checkbox"/>	STANDARD	115292	
	I-C Bracket (Aufpreis)	<input type="checkbox"/>	€ 158,00	115293	
	C-C bracket (Aufpreis)	<input type="checkbox"/>	€ 184,00	115294	
	T Bracket (Aufpreis)	<input type="checkbox"/>	€ 184,00	115295	
	I Bracket (Aufpreis)	<input type="checkbox"/>	€ 53,00	115296	
	C Flip-Up Bracket (Aufpreis)	<input type="checkbox"/>	€ 255,00	117356	
	I Flip-Up Bracket (Aufpreis)	<input type="checkbox"/>	€ 255,00	117357	
	 Dynamische Kopfstützenhalterung (Aufpreis)	10 N	<input type="checkbox"/>	€ 620,00	115310
		20 N	<input type="checkbox"/>	€ 620,00	115311
	Aufnahmestange gerade (nicht in Verbindung mit "Flip-Up Bracket")	<input type="checkbox"/>	STANDARD	117358	
	Aufnahmestange gebogen (nicht in Verbindung mit "Flip-Up Bracket")	<input type="checkbox"/>	€ 19,00	117359	

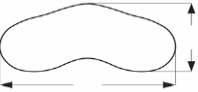
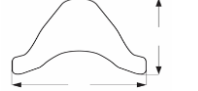
KOPFSTÜTZEN POLSTER

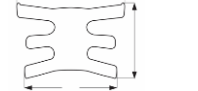
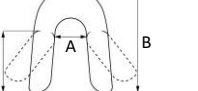
	Straight contoured pad	Small	<input type="checkbox"/>	€ 0,00	115297
		Medium	<input type="checkbox"/>	STANDARD	115298
		Large	<input type="checkbox"/>	€ 0,00	115299
	Curved contoured pad	Small	<input type="checkbox"/>	€ 74,00	115300
		Medium	<input type="checkbox"/>	€ 74,00	115301
		Large	<input type="checkbox"/>	€ 74,00	115302
	Contoured pad A	Small	<input type="checkbox"/>	€ 189,00	115303
		Medium	<input type="checkbox"/>	€ 189,00	115304
	Contoured pad X	Small	<input type="checkbox"/>	€ 289,00	115305
		Medium	<input type="checkbox"/>	€ 289,00	115306
	Contoured pad E	Small	<input type="checkbox"/>	€ 352,00	115307
		Medium	<input type="checkbox"/>	€ 352,00	115308
		Large	<input type="checkbox"/>	€ 352,00	115309
	Contoured pad Hold Tight	Small	<input type="checkbox"/>	€ 502,00	117360
		Medium	<input type="checkbox"/>	€ 502,00	117362
		Large	<input type="checkbox"/>	€ 502,00	117363

ARMLEHNEN

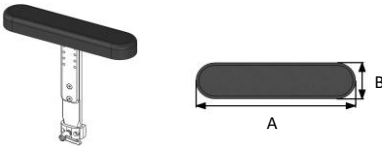
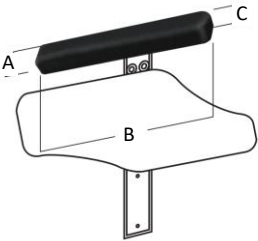
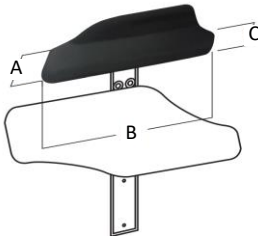
Armlehnenträger mit transparenten Seitenteilen	Armlehnenträger Standard (Höhenverstellung 18:27 cm)	<input type="checkbox"/>	Paar	STANDARD	114783
	Armlehnenträger hoch (Höhenverstellung 27:36 cm)	<input type="checkbox"/>	Paar	€ 0,00	114784
	Armlehne Kunstleder A 30 cm - B 7 cm	<input type="checkbox"/>	Paar	€ 89,00	117364
	A 5 cm - B 25 cm C 4 cm	<input type="checkbox"/>	R	€ 188,00	117178
		<input type="checkbox"/>	L	€ 188,00	117179
	A 8 cm - B 30 cm C 4 cm	<input type="checkbox"/>	R	€ 188,00	117180
		<input type="checkbox"/>	L	€ 188,00	117181
	A 8 cm - B 40 cm C 4 cm	<input type="checkbox"/>	R	€ 188,00	117182
		<input type="checkbox"/>	L	€ 188,00	117183
	A 11 cm - B 35 cm C 4 cm	<input type="checkbox"/>	R	€ 188,00	117184
		<input type="checkbox"/>	L	€ 188,00	117185
	A 10 cm - B 32 cm C 6 cm	<input type="checkbox"/>	R	€ 226,00	117186
		<input type="checkbox"/>	L	€ 226,00	117187
gepolsterte Armlehne mit Außenrand	A 12 cm - B 42 cm C 6 cm	<input type="checkbox"/>	R	€ 226,00	117188
		<input type="checkbox"/>	L	€ 226,00	117189

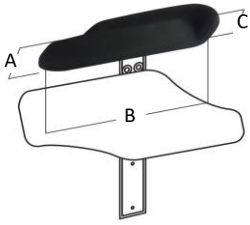
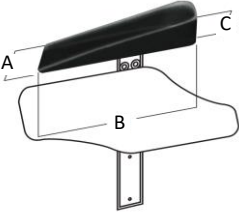
	gepolsterte Armlehne mit Außen- und Ellenbogenrand	A 10 cm - B 32 cm C 6 cm	<input type="checkbox"/> R	€ 247,00	117190
			<input type="checkbox"/> L	€ 247,00	117191
		A 12 cm - B 42 cm C 6 cm	<input type="checkbox"/> R	€ 247,00	117192
			<input type="checkbox"/> L	€ 247,00	117193
	gepolsterte Armlehne mit Außen-, Innen- und Ellenbogenrand	A 9 cm - B 35 cm C 6 cm	<input type="checkbox"/> R	€ 268,00	117194
			<input type="checkbox"/> L	€ 268,00	117195
		A 11,5 cm - B 40 cm C 6 cm	<input type="checkbox"/> R	€ 268,00	117196
			<input type="checkbox"/> L	€ 268,00	117197
		A 13 cm - B 45 cm C 6 cm	<input type="checkbox"/> R	€ 268,00	117198
	<input type="checkbox"/> L	€ 268,00	117199		

SEITENTEILE

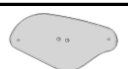
	ohne Seitenteile	<input type="checkbox"/>	STANDARD	117200
	PETG Seitenteil 27 x 8 cm	<input type="checkbox"/> Paar	€ 104,00	117373
	PETG Seitenteil 30 x 15 cm	<input type="checkbox"/> Paar	€ 104,00	117374

GURTSYSTEME WESTENFORM

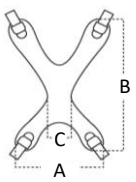
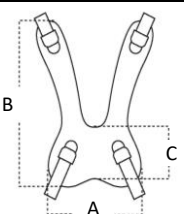
	Weste Modell "X"	A 27 cm B 31 cm C 5 cm	<input type="checkbox"/>	€ 258,00	117206
		A 29 cm B 41 cm C 6 cm	<input type="checkbox"/>	€ 258,00	117207
		A 37 cm B 51 cm C 7 cm	<input type="checkbox"/>	€ 258,00	117208
	Weste Modell "U"	A 21 cm B 31 cm C 8 cm	<input type="checkbox"/>	€ 258,00	117209
		A 28 cm B 41 cm C 10 cm	<input type="checkbox"/>	€ 258,00	117210
		A 36 cm B 51 cm C 12 cm	<input type="checkbox"/>	€ 258,00	117211
	Weste Modell "H"	A 23 - 31 cm B 31 cm	<input type="checkbox"/>	€ 258,00	117212
		A 27 - 39 cm B 41 cm	<input type="checkbox"/>	€ 258,00	117213
		A 35 - 51 cm B 51 cm	<input type="checkbox"/>	€ 258,00	117214

BECKENGURTSYSTEME

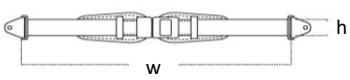
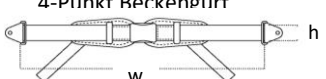
	Metallschnalle	w MAX 140 cm h 2,5 cm	<input type="checkbox"/>	€ 216,00	117215
		w MAX 160 cm h 4 cm	<input type="checkbox"/>	€ 216,00	117216
	Metallschnalle	w MAX 140 cm h 2,5 cm	<input type="checkbox"/>	€ 216,00	117219
		w MAX 160 cm h 4 cm	<input type="checkbox"/>	€ 216,00	117220

FIXIERUNGSSYSTEME

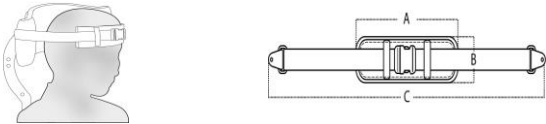
Kopfgurt		A 15 cm B 5 cm C 40 - 45 cm	<input type="checkbox"/>	€ 94,00	117223
		A 20 cm - B 5 cm C 45 - 50 cm	<input type="checkbox"/>	€ 94,00	117224

Armfixierungsgurt		A 15 cm B 7 cm C 25 - 30 cm	<input type="checkbox"/>	€ 125,00	117225
		A 20 cm B 10 cm C 30 - 35 cm	<input type="checkbox"/>	€ 125,00	117226

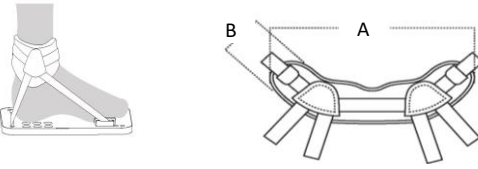
Fußknöchel- fixierungsgurt		A 23 - 28 cm B 6,5 cm	<input type="checkbox"/> Set	€ 220,00	117227
		A 27 - 34 cm B 6,5 cm	<input type="checkbox"/> Set	€ 220,00	117228
		A 29 - 38 cm B 6,5 cm	<input type="checkbox"/> Set	€ 220,00	117229

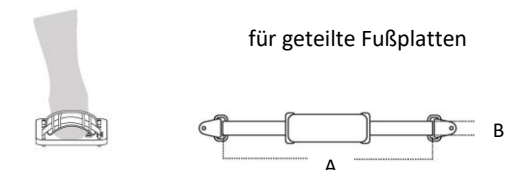
Fersenriemen		für geteilte Fußplatten		A 12 - 16 cm B 2,5 cm	<input type="checkbox"/> Set	€ 52,00	117230
				A 15 - 19 cm B 2,5 cm	<input type="checkbox"/> Set	€ 52,00	117231
				A 18 - 22 cm B 2,5 cm	<input type="checkbox"/> Set	€ 52,00	117232

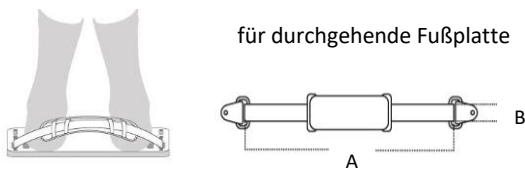
Fersenriemen		für durchgehende Fußplatte		A 25 - 29 cm B 2,5 cm	<input type="checkbox"/>	€ 52,00	117233
				A 30 - 34 cm B 2,5 cm	<input type="checkbox"/>	€ 52,00	117234
				A 35 - 39 cm B 2,5 cm	<input type="checkbox"/>	€ 52,00	117235

Fußriemen		für geteilte Fußplatten		A 12 - 16 cm B 2,5 cm	<input type="checkbox"/> Set	€ 83,00	117236
				A 15 - 19 cm B 2,5 cm	<input type="checkbox"/> Set	€ 83,00	117237
				A 18 - 22 cm B 2,5 cm	<input type="checkbox"/> Set	€ 83,00	117238

Fußriemen		für durchgehende Fußplatte		A 25 - 29 cm B 2,5 cm	<input type="checkbox"/>	€ 83,00	117239
				A 30 - 34 cm B 2,5 cm	<input type="checkbox"/>	€ 83,00	117240
				A 35 - 39 cm B 2,5 cm	<input type="checkbox"/>	€ 83,00	117241

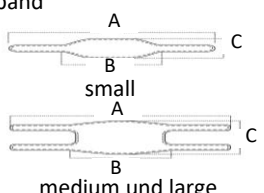
Wadenband		A 75 cm - B 26 cm - C 10 cm	<input type="checkbox"/>	€ 162,00	117242
		A 90 cm - B 34 cm - C 15 cm	<input type="checkbox"/>	€ 162,00	117243
		A 105 cm - B 42 cm - C 20 cm	<input type="checkbox"/>	€ 162,00	117244

BEINSTÜTZEN & FUßPLATTEN

Beinwinkelverstellung

Beinstütze mit festem Winkel (75°) - abnehmbar € 0,00 114785

winkelverstellbare Beinstützen (90°-160°) - abnehmbar STANDARD 114786



Dynamisch, winkelverstellbare Beinstütze (90°-170°)*
Inkl Dynamische, durchgehende Fußplatte. € 998,00 114787
*Nur mit durchgehende Fußplatte

Fußplatte **Separate Fußplatten*** STANDARD 114788
*nicht in Kombination mit Dynamische Beinstütze

Durchgehende Fußplatte € 0,00 114789

Wadenplatten **Wadenband, gepolstert** € 78,00 114791

PU Wadenplatten (Paar) € 174,00 114792

Knieführung  **A 21 cm - B 26 cm** R € 52,00 117174
C 2 cm L € 52,00 117175

OPTIONEN

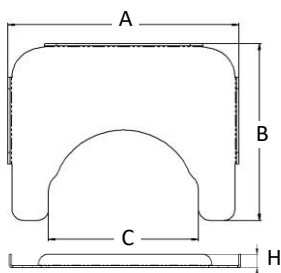

PETG Therapietisch
(inkl. Tischhalterung)

Extra Small

A 57 cm - B 47 cm - C 37 cm € 283,00 117375
H 4 cm

Small

A 67 cm - B 57 cm - C 47 cm € 283,00 117376
H 4 cm

Large

A 72 cm - B 57 cm - C 52 cm € 283,00 117377
H 4 cm



4 Punkt Transportösen - crash getestet nach ISO 7176-19 € 399,00 115362

AKZENTFARBE

weiss [RAL 9016] 114794

grün [RAL 6920] 114801

metallicrot [RAL 3002] 114795

himmelblau [RAL 5015] 114802

signalrot [RAL 3020] 114796

ultramarinblau [RAL 5002] 114803

pink [RAL 4010] 114797

blaulila [RAL 4005] 114804

hellrosa [RAL 3015] 114798

signalviolett [RAL 4008] 114805

orange [RAL 2004] 114799

aluminium [RAL 9006] 114806

gelb [RAL 1018] 114800

grau [RAL 7043] 114807

ANMERKUNGEN